

Available Models

Remote I/O Terminal Basic Units

Model number	Specification
DRT2-ID16	16 inputs, NPN
DRT2-ID16-1	16 inputs, PNP
DRT2-OD16	16 outputs, NPN
DRT2-OD16-1	16 outputs, PNP

One Basic Unit and one Expansion Unit can be combined freely.

Remote I/O Terminal Expansion Unit

Model number	Specification
XWT-ID08	8 expansion inputs, NPN
XWT-ID08-1	8 expansion inputs, PNP
XWT-OD08	8 expansion outputs, NPN
XWT-OD08-1	8 expansion outputs, PNP
XWT-ID16	16 expansion inputs, NPN
XWT-ID16-1	16 expansion inputs, PNP
XWT-OD16	16 expansion outputs, NPN
XWT-OD16-1	16 expansion outputs, PNP

Dimensions

Remote I/O Terminal Basic Units

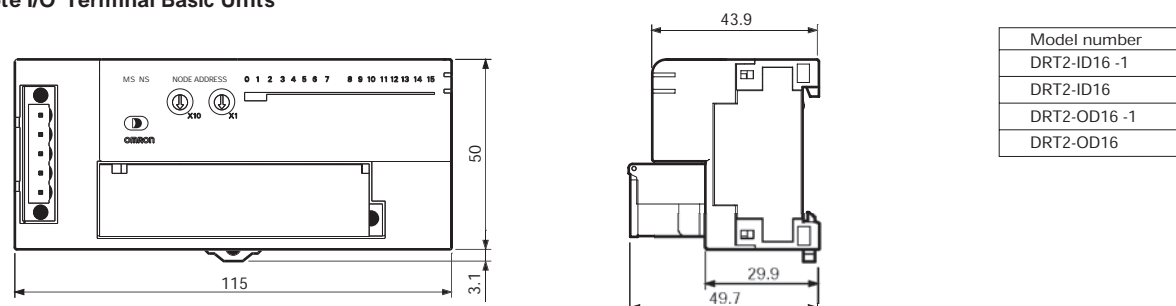

Remote I/O Terminal Expansion Units

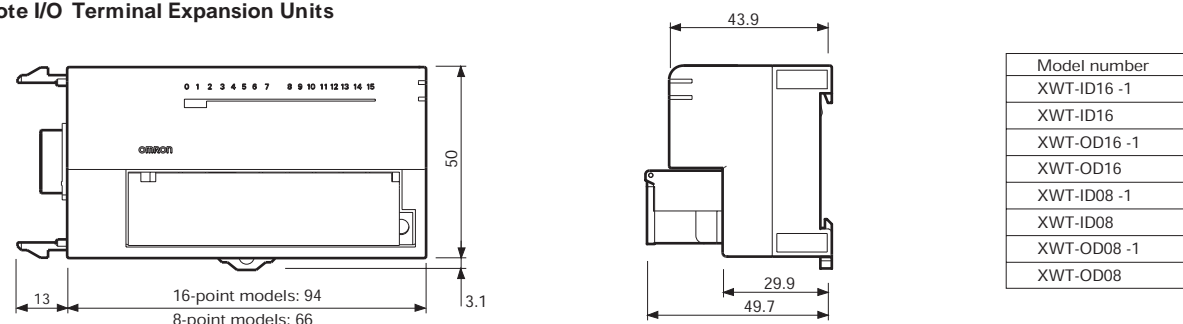

DeviceNet Smart Slaves

Adding a new dimension to DeviceNet with remote maintenance.

Remote I/O Terminals

DRT2-ID16(-1)/O D16(-1)
XWT-ID16(-1)/O D16(-1)
XWT-ID08(-1)/O D08(-1)



Note: Do not use this document to operate the Unit.

OMRON Corporation

FA Systems Division H.Q.
66 Matsumoto
Mishima-city, Shizuoka 411-8511
Japan
Tel: (81)55-977-9181
Fax: (81)55-977-9045

Regional Headquarters

OMRON EUROPE B.V.
Wegalaan 67-69, NL-2132 JD Hoofddorp
The Netherlands
Tel: (31)2356-81-300/Fax: (31)2356-81-388

OMRON ELECTRONICS LLC
1 East Commerce Drive, Schaumburg, IL 60173
U.S.A.
Tel: (1)847-843-7900/Fax: (1)847-843-8568

OMRON ASIA PACIFIC PTE. LTD.
83 Clemenceau Avenue,
#11-01, UE Square,
Singapore 239920
Tel: (65)6835-3011/Fax: (65)6835-2711

Authorized Distributor:

Note: Specifications subject to change without notice.

Cat. No. R097-E1-01
Printed in Japan
0502-2M



Use production site information in a variety of applications, such as maintenance and quality control.

OMRON's DRT2-series Smart Slaves do not just input and output ON/OFF signals. They collect a variety of value-added information to help increase the rate of operation without changing the wiring for existing DeviceNet networks. In particular, they allow the separation of control systems and maintenance systems so that maintenance systems can be created independently of control systems.

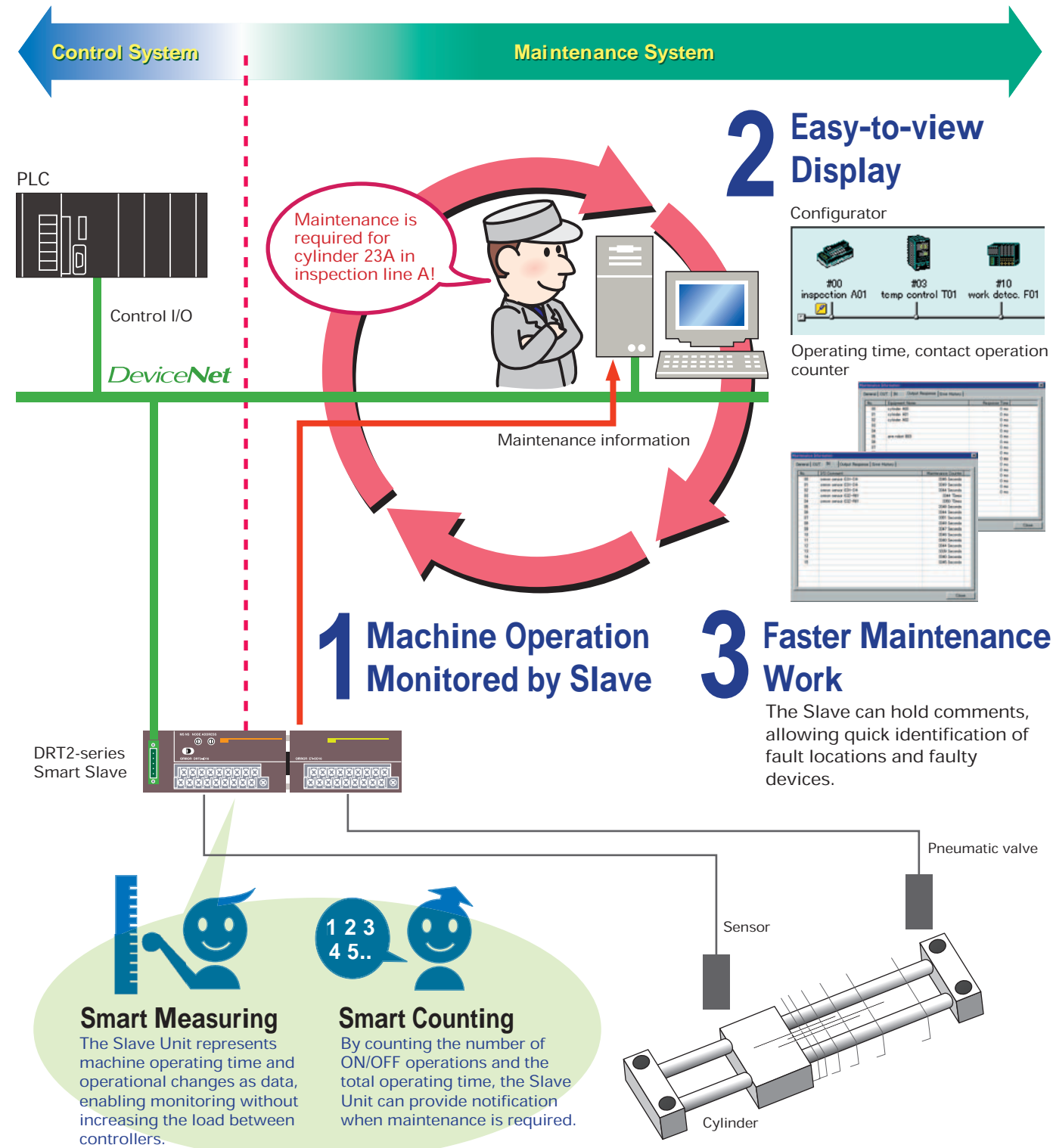

Collect a variety of data from maintenance systems without influencing control systems and productivity.

All data can be converted to electronic format and, by combining with an OMRON PLC (CS/CJ Series), checked directly from Ethernet or the Internet to allow remote maintenance.

Information monitoring for each Slave

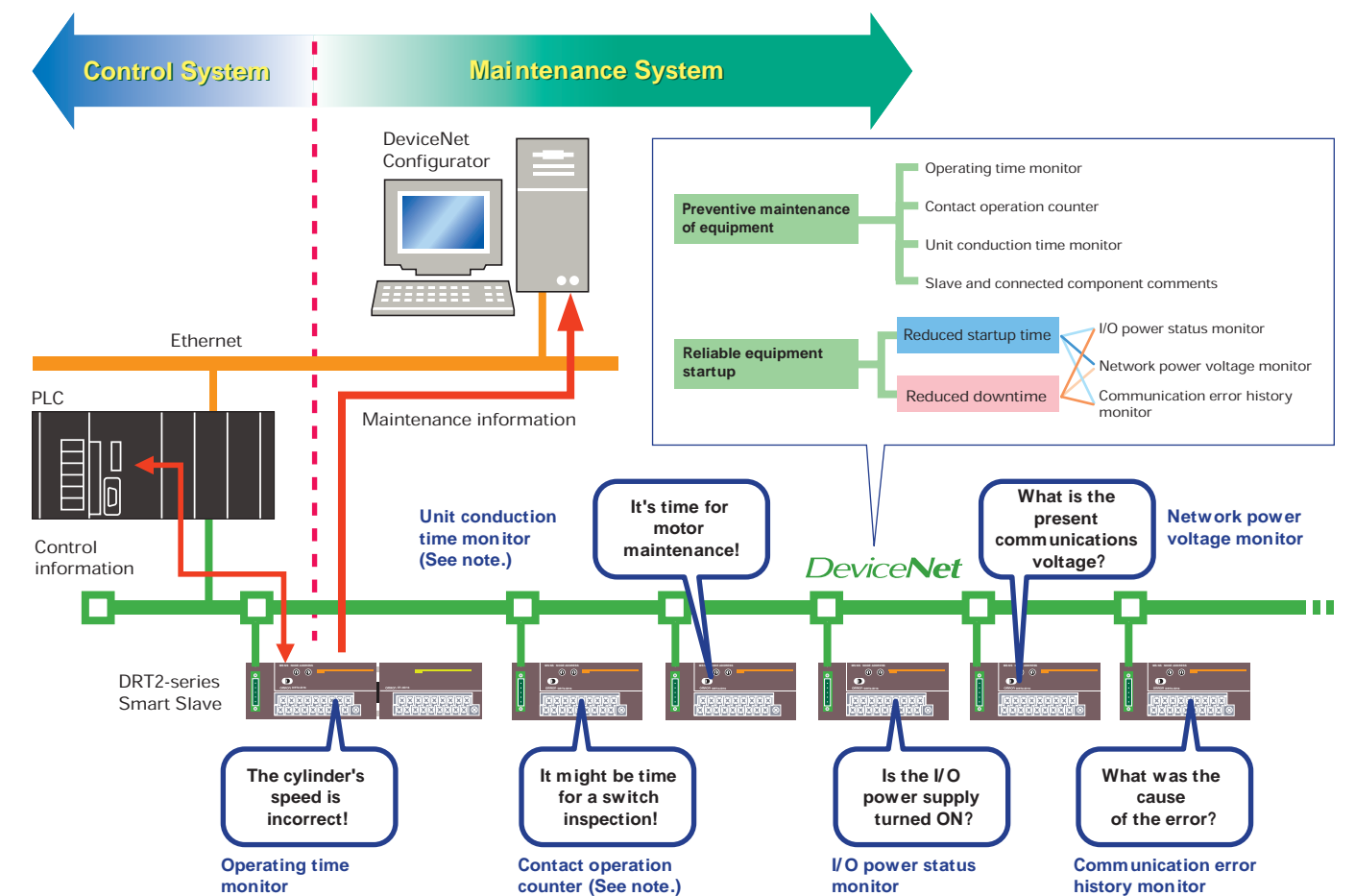
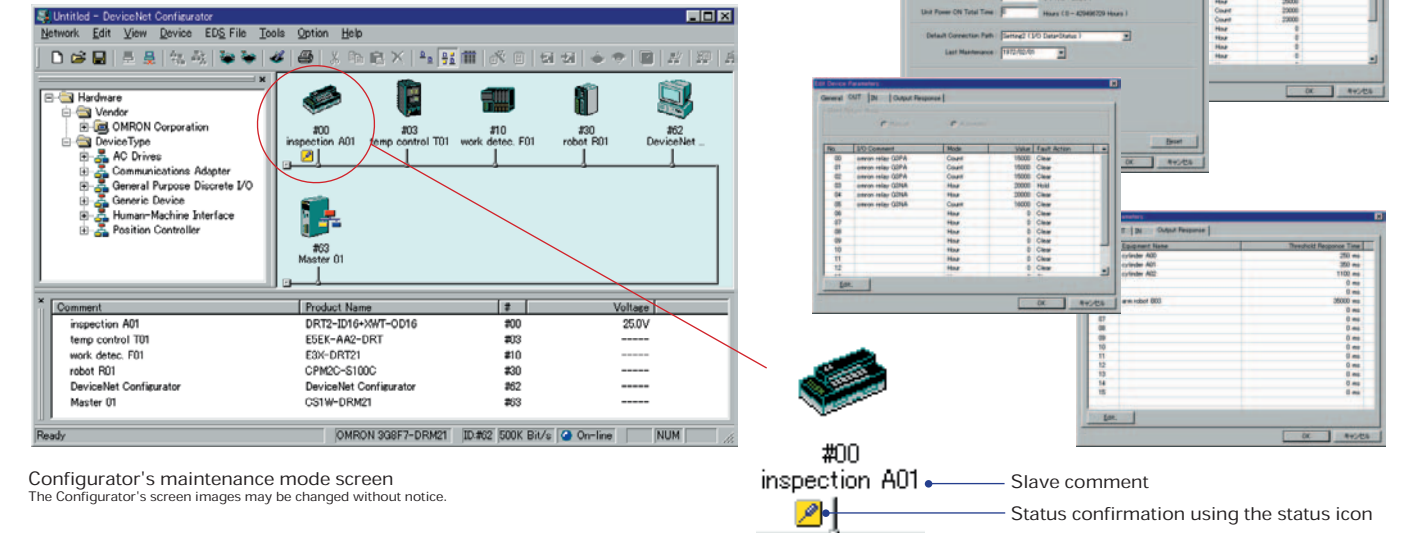

Note: The contact operation counter function and the unit conduction time monitor function cannot be used simultaneously.

Contributing to preventive maintenance of equipment.

Errors in machine operation can be detected by measuring the time interval between output and input.

● Operating Time Monitor Function

The Slave can perform high-speed measurement of the interval between the time an output is turned ON by a specified bit and the time an input is turned ON. It is possible to read this measurement result (between 2 and 65,535 ms) using the Configurator or explicit message communications. This feature contributes to preventive maintenance by allowing the detection of mechanical deterioration, such as air leaks in cylinders. A threshold value can also be set in the Slave so that a flag turns ON when the time becomes longer than a set time.

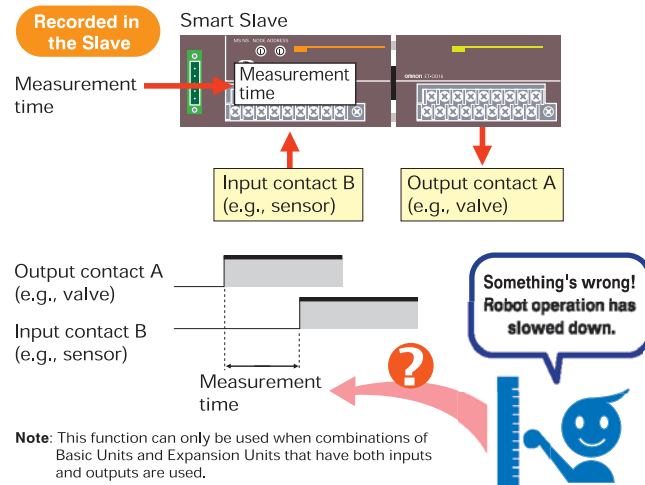

Provides notification of maintenance timing for I/O devices, such as switches and actuators.

● Contact Operation Counter Function

This function provides notification of maintenance timing for input and output devices, such as switches and actuators.

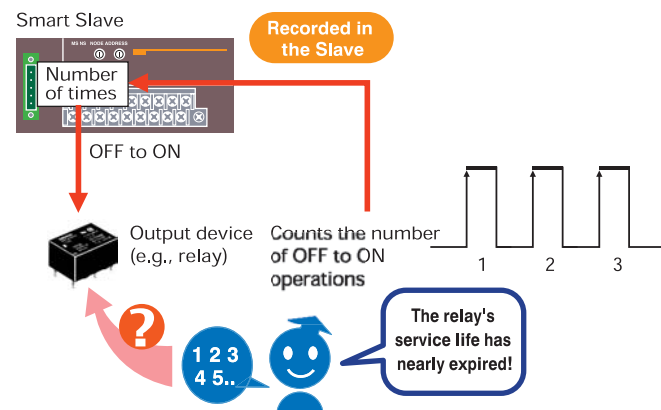

● Unit Conduction Time Monitor Function

Every 6 minutes the Slave records the total conduction time of, for example, a motor. This record can be read using the Configurator or explicit message communications.

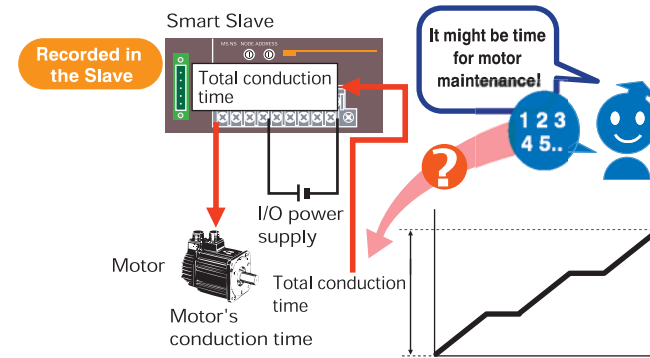

Note: The contact operation counter function and the unit conduction time monitor function cannot be used simultaneously.

A threshold value can be set in the Slave so that a flag turns ON when this value is exceeded. (This is possible with both the contact operation counter function and the unit conduction time monitor function.) This makes it possible to identify when parts approach the end of their service life, and provides useful data for preventive maintenance.

Identification of fault locations and confirmation of replacement parts can be performed quickly.

● Slave comment/connected component comment function

● Slave comment function

Setting the location in the Slave's internal comments means that the Slave can be identified from the Configurator.

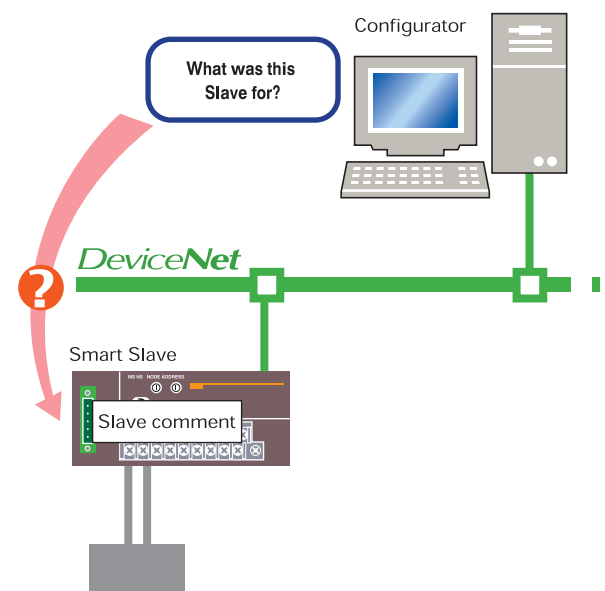

Configurator's maintenance mode screen

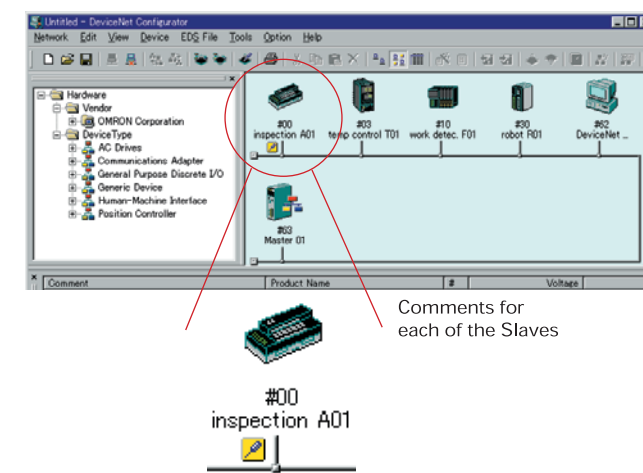

● Connected Component Comment Function

By setting the maker name and model number for each contact (e.g., sensors and valves), comments can be set for each of the input and output contacts in the Slaves.

Configurator screen

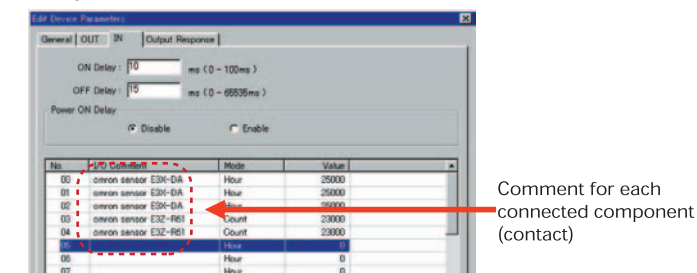

Confirmation and preparation of replacement parts when failures occur can be performed quickly.

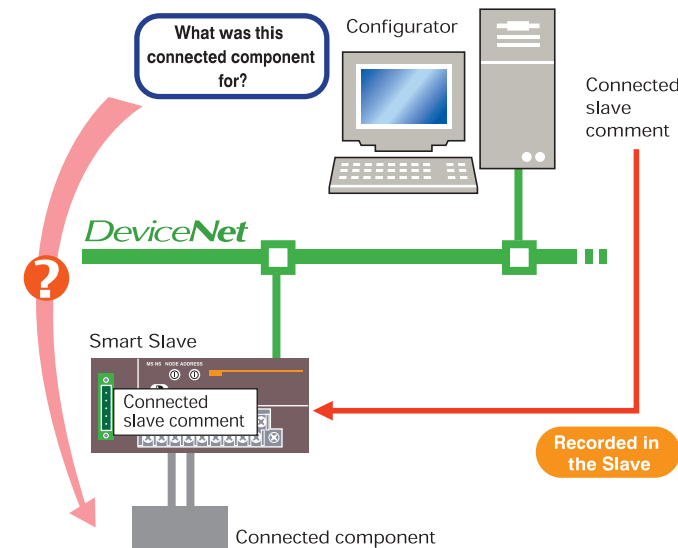

All of this data can be handled as electronic data and can therefore be used in systems to, for example, create electronic manuals or databases of maintenance parts.

Reliable network startup.

Networks can be started up simply by making rotary switch settings and connecting network cables.

● Easy Node Address Setting

Node addresses are set with easy-to-use rotary switches.

Node address setting using rotary switches



● Automatic Baud Rate Recognition Function

The automatic baud rate recognition function eliminates the need for DIP switches.

● No Wiring Required for Unit's Internal Circuit Power Supply

Power for the Unit's internal circuits is obtained from the network power and so no wiring is required for the Unit's internal circuit power supply.

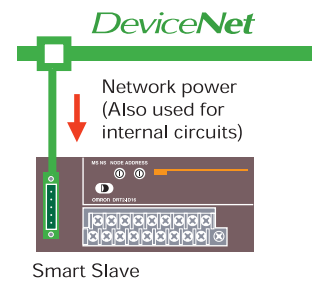

The network power voltage status and the I/O power status can be understood at a glance via the network.

● Network Power Voltage Monitor Function

The network power voltage is recorded in the Slave (network power voltage monitor function). It is also possible to detect whether the I/O power supply is turned ON, and to output a warning signal if it is not (I/O power status monitor function). This means that the status of the network power voltage and I/O power supply for each Smart Slave can be confirmed at a glance from the Configurator, contributing to reductions in startup time.

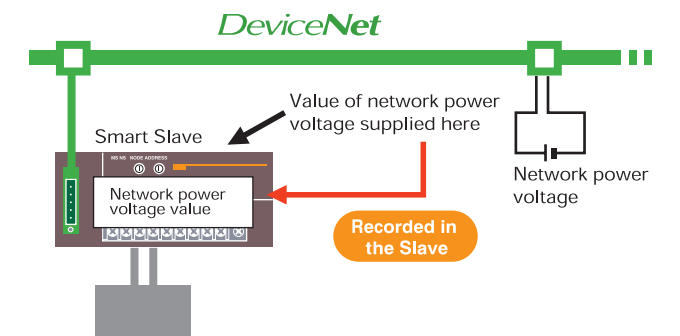

● I/O Power Status Monitor Function

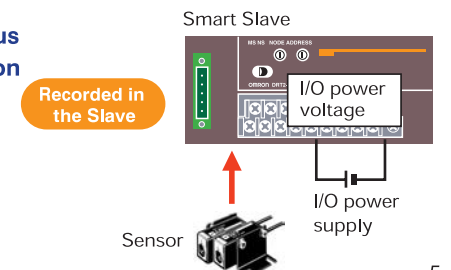

Causes for communication errors can be monitored.

● Communication Error History Monitor Function

Information (i.e., communication error code and network power voltage at the time) for four previous errors can be recorded in the Slave. This error history can be read from Smart Slaves that are removed from the network when correcting an error, enabling more effective maintenance.

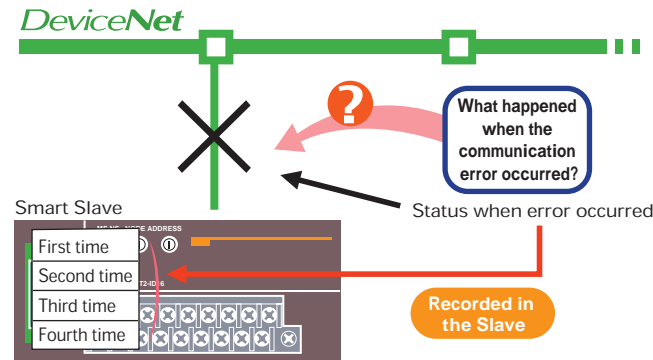

Basic Functions Also Improved

Improved Structural Flexibility

● Smallest in Its Class

The width of the Basic Unit is 115 mm (77% of 150-mm DRT1-series models) and the width of the Expansion Unit is 94 mm, giving a total expanded width of 209 mm, making it the smallest device of its class in the industry.

● Easy Mounting and Dismounting of Terminal Blocks

Terminal blocks can be mounted and dismounted with ease.

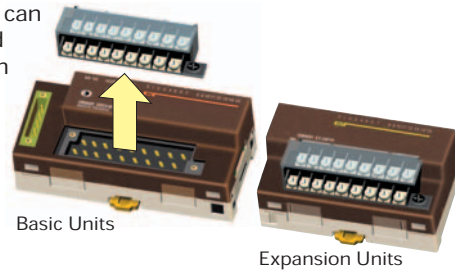

● Easy Expansion with Expansion Units

The Smart Slaves can be expanded easily by freely combining Expansion Units with Basic Units using snap-on mounting. This means less wiring work is required.

● Screw-less Clamp Communications Connectors



Wiring can be performed by inserting post terminals.

The connector allows easy checking using a tester.

Improved Structural Flexibility

● Input Filter Function

The influence of noise can be removed using the ON response time. Also, very small pulses that are shorter than the communications time can be handled using the OFF response time.

● Function for Handling Sensor Inrush Current

In order to prevent incorrect input due to inrush current when, for example, power to a sensor is turned ON, the Slave can be set not to accept input for 100 ms after the input power supply is turned ON.

■ General Specifications

Item	Specification
Network power voltage	11 to 25 VDC (supplied from the communications connector)
I/O power supply voltage	20.4 to 26.4 VDC (24 VDC -15% to +10%)
Noise immunity	Conforms to IEC61000-4-4: 2 kV (power lines)
Vibration resistance	10 to 50 Hz, 0.7-mm double amplitude
Shock resistance	200m/s ²
Dielectric strength	500 VAC (between isolated circuits)
Insulation resistance	20 M min. (between isolated circuits)
Ambient operating temperature	-10 to 55 C
Ambient operating humidity	35% to 85%
Ambient atmosphere	No corrosive gases
Ambient storage temperature	-20 to +65 C
Mounting method	35-mm DIN track mounting
Mounting strength	50 N (in directions other than the DIN track direction), 10 N (in the DIN track direction)
Screw tightening torque	M3 (power supply, I/O terminals): 0.3 to 0.5 N·m

■ Input Specifications

Item	Specification	
Model number	DRT2-ID16	DRT2-ID16-1
Internal I/O common processing	NPN	PNP
Number of I/O points	16 inputs	
ON voltage	15 VDC min. (between each input terminal and V)	15 VDC min. (between each input terminal and G)
OFF voltage	5 VDC min. (between each input terminal and V)	5 VDC min. (between each input terminal and G)
OFF current	1.0 mA max. per point (at 24 VDC)	
Input current	6.0 mA max. per point at 24 VDC; 3.0 mA max. per point at 17 VDC	
ON delay time	1.5 ms max.	
OFF delay time	1.5 ms max.	
Number of points per common	16 points per common	

■ Output Specifications

Item	Specification	
Model number	DRT2-OD16	DRT2-OD16-1
Internal I/O common processing	NPN	PNP
Number of I/O points	16 outputs	
Rated output current	0.5 A per point, 4.0 A per common	
Residual voltage	1.2 V max. (0.5 A between each output terminal and G)	1.2 V max. (0.5 A between each output terminal and V)
Leakage current	0.1 mA max.	
ON delay time	0.5 ms max.	
OFF delay time	1.5 ms max.	
Number of points per common	16 points per common	

■ Internal Circuit Diagrams

Remote I/O Terminals (Models with 16 Transistor Inputs)
DRT2-ID16 (NPN)/DRT2-ID16-1 (PNP)

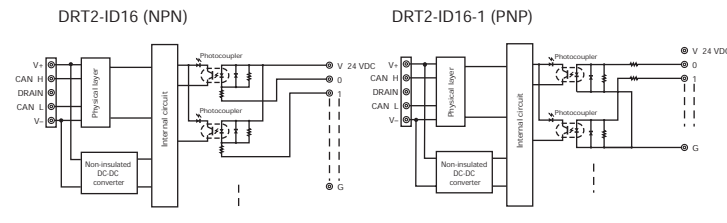

Remote I/O Terminals (Models with 16 Transistor Outputs)
DRT2-OD16 (NPN)/DRT2-OD16-1 (PNP)

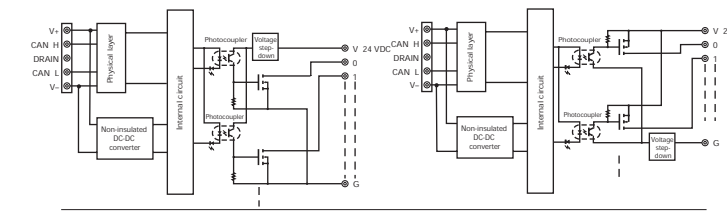

Remote I/O Terminal Expansion Units (Models with 8 Transistor Inputs)
XWT-ID08 (NPN)/ID08-1 (PNP)

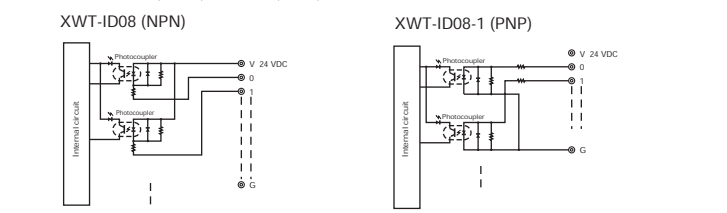

Remote I/O Terminal Expansion Units (Models with 8 Transistor Outputs)
XWT-OD08 (NPN)/OD08-1 (PNP)

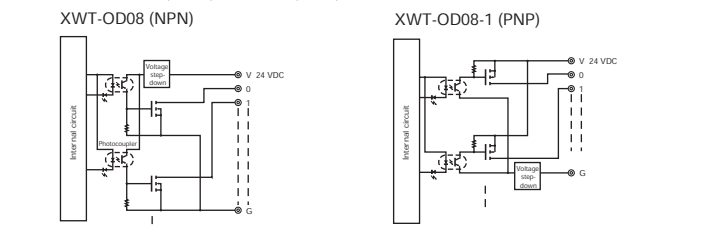

Remote I/O Terminal Expansion Units (Models with 16 Transistor Inputs)
XWT-ID16 (NPN)/ID16-1 (PNP)

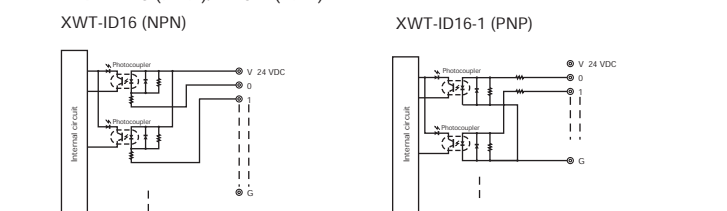

Remote I/O Terminal Expansion Units (Models with 16 Transistor Outputs)
XWT-OD16 (NPN)/OD16-1 (PNP)

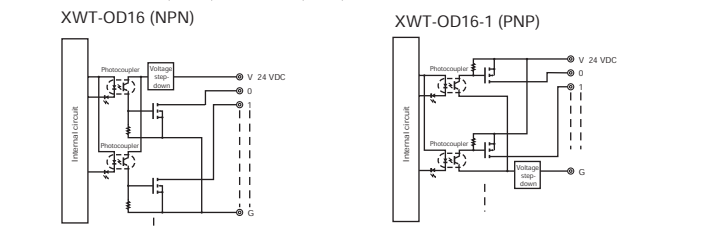

■ Wiring Diagrams

Remote I/O Terminals (Models with 16 Transistor Inputs)
DRT2-ID16 (NPN)/DRT2-ID16-1 (PNP)

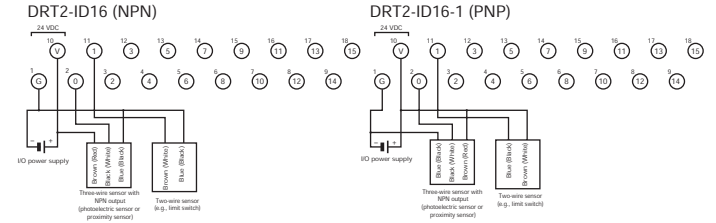

Remote I/O Terminals (Models with 16 Transistor Outputs)
DRT2-OD16 (NPN)/DRT2-OD16-1 (PNP)

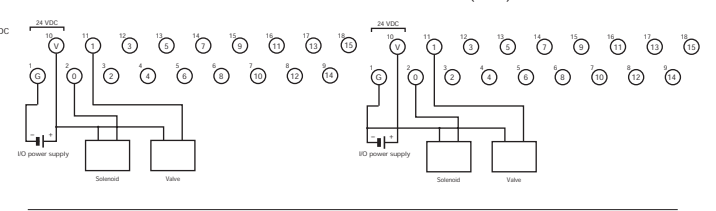

Remote I/O Terminal Expansion Units (Models with 8 Transistor Inputs)
XWT-ID08 (NPN)/ID08-1 (PNP)

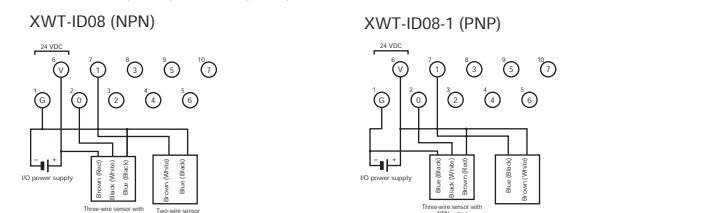

Remote I/O Terminal Expansion Units (Models with 8 Transistor Outputs)
XWT-OD08 (NPN)/OD08-1 (PNP)

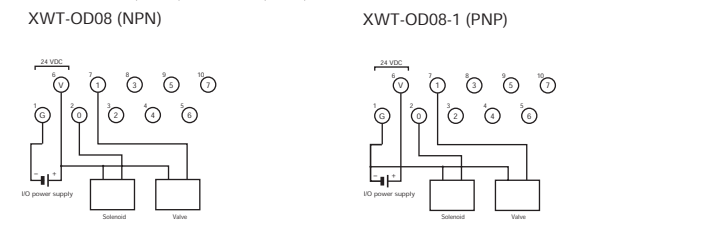

Remote I/O Terminal Expansion Units (Models with 16 Transistor Inputs)
XWT-ID16 (NPN)/ID16-1 (PNP)

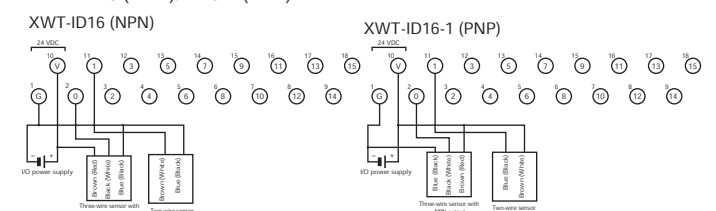

Remote I/O Terminal Expansion Units (Models with 16 Transistor Outputs)
XWT-OD16 (NPN)/OD16-1 (PNP)

